

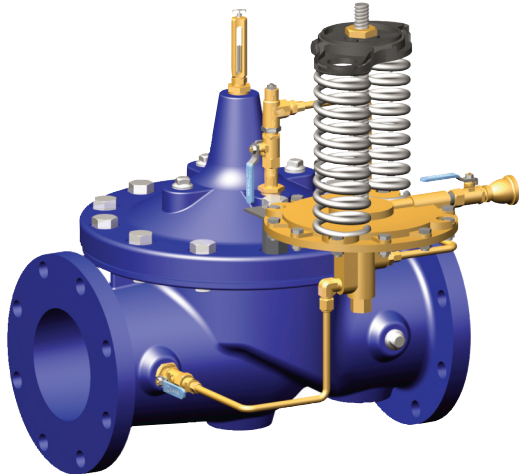

— MODEL — **210-27**

Altitude and Solenoid Shut-Off Valve with Return Flow Feature



- **Accurate and Repeatable Level Control**
- **Easy Interface With Remote Control Systems**
- **Drip Tight Positive Shut Off**
- **Reliable Hydraulic Operatio/ Easy Adjustable Control**

The Cla-Val Model 210-27 Altitude Valve controls the high water level in reservoirs with out the need for floats or other devices. It is a non-throttling valve that remains fully open until the solenoid is activated or the shut-off point of the hydraulic pilot control is reached. The valve closes at high water level and opens for return flow when the pressure at the valve inlet is less than reservoir pressure.

This valve is hydraulically-operated and pilot-controlled. The level pilot control operates on the differential in forces between a spring load and reservoir head level. When force of the spring is overcome by the force of reservoir head, the pilot shifts and closes main valve. Desired high water level is set by adjusting the spring force. The pilot control measures the reservoir head through a customer supplied separate sensing line* connected directly to the reservoir. A three-way solenoid control and a high-capacity three-way pilot control valve provide override shut-off of valve from a remote location, such as a SCADA control system. It is furnished either normally open (de-energize solenoid to open) or normally closed (energize solenoid to open).

The valve can also be furnished with auxiliary controls to meet the need for additional functions, such as: pressure sustaining, rate of flow control, pressure reduction, etc.

Schematic Diagram

Item	Description
1	100-01 Hytrol Main Valve
2	CDS6A Altitude Control
3	X101 Valve Position Indicator
4	Bell Reducer
5	102C-3H Three Way Valve
6.	CS3 Solenoid Control
7	CSC Swing Check
8	CV Flow Control (Closing)
9	CK2 Isolation Valve

Optional Features

Item	Description
A	X46A Flow Clean Strainer
B	CK2 (Isolation Valve)
H	CDC Check Valve
P	X141 Pressure Gauge
R	Reservoir Gauge with Tester
S	CV Flow Control (Opening)
Y	X43 "Y" Strainer

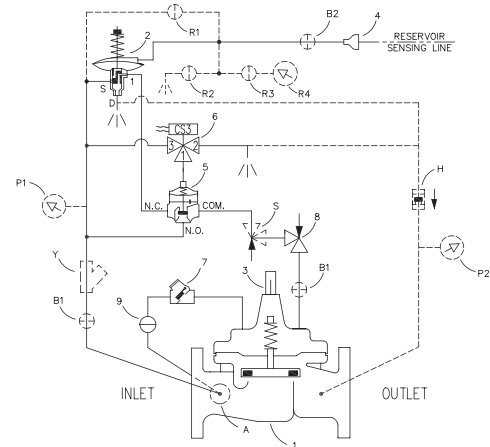

Typical Applications

Used on reservoirs where water is supplied and withdrawn through the Altitude Valve. Valve closes at the desired high water level controlled remotely via SCADA system signal to solenoid or automatically with preset level control (usually set higher). Also, valve automatically opens for return flow when the pressure at the valve inlet lowers below the reservoir head pressure. For more information see data sheet E-CDS6A.

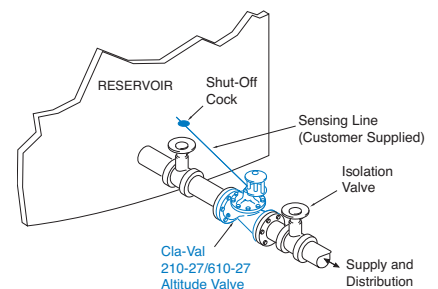

*Note: The reservoir pressure sensing line should be 3/4" minimum I.D. installed with a 2° slope from valve to reservoir to avoid air pockets.

Note: We recommend protecting tubing and valve from freezing temperatures.

Model 210-27 (Uses Model 100-01 Main Valve)

Pressure Ratings (Recommended Maximum Pressure - psi)

Valve Body & Cover		Pressure Class				
		Flanged			Grooved	Threaded
Grade	Material	ANSI Standards*	150 Class	300 Class	300 Class	End‡ Details
ASTM A536	Ductile Iron	B16.42	250	400	400	400
ASTM A216-WCB	Cast Steel	B16.5	285	400	400	400
UNS 87850	Bronze	B16.24	225	400	400	400

Note: * ANSI standards are for flange dimensions only.
 Flanged valves are available faced but not drilled.
 ‡ End Details machined to ANSI B2.1 specifications.
Valves for higher pressure are available; consult factory for details

Materials

Component	Standard Material Combinations		
Body & Cover	Ductile Iron	Cast Steel	Bronze
Available Sizes	2" - 36" 50 - 900 mm	2" - 16" 400 - 900 mm	2" - 16" 400 - 900 mm
Disc Retainer & Diaphragm Washer	Cast Iron	Cast Steel	Bronze
Trim: Disc Guide, Seat & Cover Bearing	Bronze is Standard Stainless Steel is Optional		
Disc	Buna-N® Rubber		
Diaphragm	Nylon Reinforced Buna-N® Rubber		
Stem, Nut & Spring	Stainless Steel		
For material options not listed, consult factory. Cla-Val manufactures valves in more than 50 different alloys.			

Dimensions
(In inches)

Cover Capacity

Liquid Volume Displaced from Diaphragm Chamber When Valve Opens or Closes

Valve Size	Displacement
2"	.032 gal
2 1/2"	.043 gal
3"	.080 gal
4"	.169 gal
6"	.531 gal
8"	1.26 gal
10"	2.51 gal
12"	4.00 gal
14"	6.50 gal
16"	9.57 gal
18"	11.00 gal
20"	12.00 gal
24"	29.00 gal
36"	90.00 gal

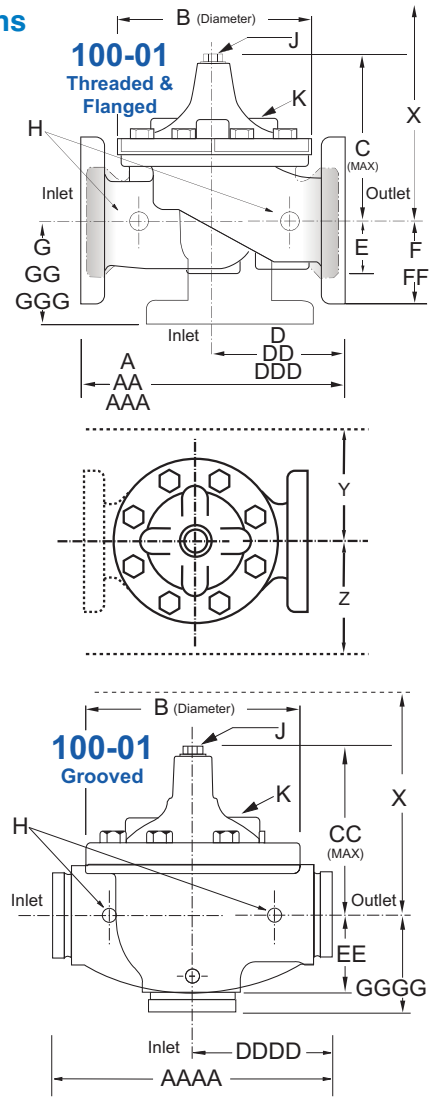

Model 210-27 Dimensions (In Inches)

Valve Size (Inches)	2	2 1/2	3	4	6	8	10	12	14	16	18	20	24	30	36
A Threaded	9.38	11.00	12.50	—	—	—	—	—	—	—	—	—	—	—	—
AA 150 ANSI	9.38	11.00	12.00	15.00	20.00	25.38	29.75	34.00	39.00	41.38	46.00	52.00	61.50	63.00	72.75
AAA 300 ANSI	10.00	11.62	13.25	15.62	21.00	26.38	31.12	35.50	40.50	43.50	47.64	53.62	63.24	64.50	74.75
AAAA Grooved End	9.00	11.00	12.50	15.00	20.00	25.38	—	—	—	—	—	—	—	—	—
B Diameter	6.62	8.00	9.12	11.50	15.75	20.00	23.62	28.00	32.75	35.50	41.50	45.00	53.16	56.00	66.00
C Maximum	6.50	7.56	8.19	10.62	13.38	16.00	17.12	20.88	24.19	25.00	39.06	41.90	43.93	54.60	59.00
CC Maximum Grooved End	5.75	6.88	7.25	9.31	12.12	14.62	—	—	—	—	—	—	—	—	—
D Threaded	4.75	5.50	6.25	—	—	—	—	—	—	—	—	—	—	—	—
DD 150 ANSI	4.75	5.50	6.00	7.50	10.00	12.69	14.88	17.00	19.50	20.81	—	—	30.75	—	—
DDD 300 ANSI	5.00	5.88	6.38	7.88	10.50	13.25	15.56	17.75	20.25	21.62	—	—	31.62	—	—
DDDD Grooved End	4.75	—	6.00	7.50	—	—	—	—	—	—	—	—	—	—	—
E	1.50	1.69	2.06	3.19	4.31	5.31	9.25	10.75	12.62	15.50	12.95	15.00	17.75	21.31	24.56
EE Grooved End	2.50	2.88	3.12	4.25	6.00	7.56	—	—	—	—	—	—	—	—	—
F 150 ANSI	3.00	3.50	3.75	4.50	5.50	6.75	8.00	9.50	10.50	11.75	15.00	16.50	19.25	22.50	28.50
FF 300 ANSI	3.25	3.75	4.13	5.00	6.25	7.50	8.75	10.25	11.50	12.75	15.00	16.50	19.25	24.00	30.00
G Threaded	3.25	4.00	4.50	—	—	—	—	—	—	—	—	—	—	—	—
GG 150 ANSI	3.25	4.00	4.00	5.00	6.00	8.00	8.62	13.75	14.88	15.69	—	—	22.06	—	—
GGG 300 ANSI	3.50	4.31	4.38	5.31	6.50	8.50	9.31	14.50	15.62	16.50	—	—	22.90	—	—
GGGG Grooved End	3.25	—	4.25	5.00	—	—	—	—	—	—	—	—	—	—	—
H NPT Body Tapping	0.375	0.50	0.50	0.75	0.75	1.00	1.00	1.00	1.00	1.00	1.00	1.00	1.00	2.00	2.00
J NPT Cover Center Plug	0.50	0.50	0.50	0.75	0.75	1.00	1.00	1.25	1.50	2.00	1.00	1.00	1.00	2.00	2.00
K NPT Cover Tapping	0.375	0.50	0.50	0.75	0.75	1.00	1.00	1.00	1.00	1.00	1.00	1.00	1.00	2.00	2.00
Stem Travel	0.60	0.70	0.80	1.10	1.70	2.30	2.80	3.40	4.00	4.50	5.10	5.63	6.75	7.50	8.50
Approx. Ship Weight (lbs)	35	50	70	140	285	500	780	1165	1600	2265	2982	3900	6200	7703	11720
Approx. X Pilot System	13	14	15	17	29	31	33	36	40	40	43	47	68	79	85
Approx. Y Pilot System	9	10	11	12	20	22	24	26	29	30	32	34	39	40	45
Approx. Z Pilot System	9	10	11	12	20	22	24	26	29	30	32	34	39	42	47

Model 210-27 Metric Dimensions (Uses Main Valve Model 100-01)

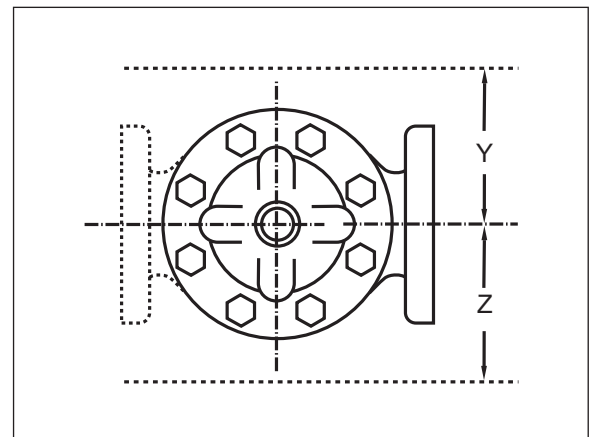
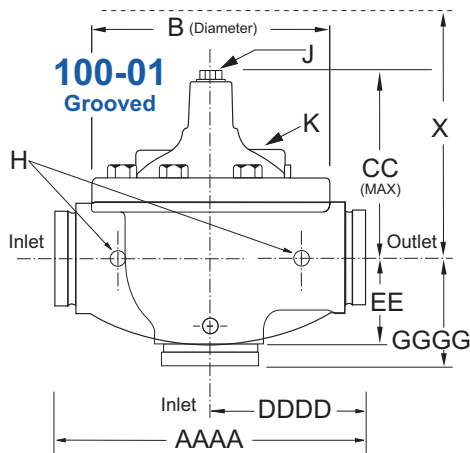
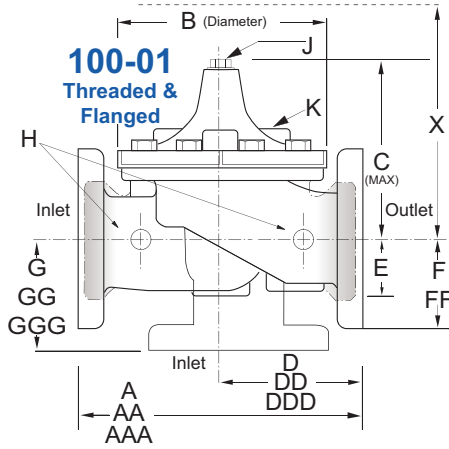

210-27 Dimensions (mm)

Valve Size (mm)	50	65	80	100	150	200	250	300	350	400	450	500	600	750	900
A Threaded	238	279	318	—	—	—	—	—	—	—	—	—	—	—	—
AA 150 ANSI	238	279	305	381	508	645	756	864	991	1051	1168	1321	1562	1600	1848
AAA 300 ANSI	254	295	337	397	533	670	790	902	1029	1105	1210	1326	1606	1638	1899
AAAA Grooved End	228	279	318	381	508	645	—	—	—	—	—	—	—	—	—
B Diameter	168	203	232	292	400	508	600	711	832	902	1054	1143	1350	1422	1676
C Maximum	165	192	208	270	340	406	435	530	614	635	992	1064	1116	1387	1499
CC Maximum Grooved End	146	175	184	236	308	371	—	—	—	—	—	—	—	—	—
D Threaded	121	140	159	—	—	—	—	—	—	—	—	—	—	—	—
DD 150 ANSI	121	140	152	191	254	322	378	432	495	528	—	—	781	—	—
DDD 300 ANSI	127	149	162	200	267	337	395	451	514	549	—	—	803	—	—
DDDD Grooved End	121	—	152	191	—	—	—	—	—	—	—	—	—	—	—
E	38	43	52	81	110	135	235	273	321	394	329	381	451	541	624
EE Grooved End	64	73	79	108	152	192	—	—	—	—	—	—	—	—	—
F 150 ANSI	76	89	95	114	140	171	203	241	267	298	381	419	489	572	724
FF 300 ANSI	83	95	105	127	159	191	222	260	292	324	381	419	489	610	762
G Threaded	83	102	114	—	—	—	—	—	—	—	—	—	—	—	—
GG 150 ANSI	83	102	102	127	152	203	219	349	378	399	—	—	560	—	—
GGG 300 ANSI	89	110	111	135	165	216	236	368	397	419	—	—	582	—	—
GGGG Grooved End	83	—	108	127	—	—	—	—	—	—	—	—	—	—	—
H NPT Body Tapping	0.375	0.50	0.50	0.75	0.75	1.00	1.00	1.00	1.00	1.00	1.00	1.00	1.00	2.00	2.00
J NPT Cover Center Plug	0.50	0.50	0.50	0.75	0.75	1.00	1.00	1.25	1.50	2.00	1.00	1.00	1.00	2.00	2.00
K NPT Cover Tapping	0.375	0.50	0.50	0.75	0.75	1.00	1.00	1.00	1.00	1.00	1.00	1.00	1.00	2.00	2.00
Stem Travel	15	18	20	28	43	58	71	86	102	114	130	143	171	190	216
Approx. Ship Weight (kgs)	16	23	32	64	129	227	354	528	726	1027	1353	1769	2812	3494	5316
Approx. X Pilot System	331	356	381	432	737	788	839	915	1016	1016	1093	1194	1728	2007	2159
Approx. Y Pilot System	229	254	280	305	508	559	610	661	737	762	813	864	991	1016	1143
Approx. Z Pilot System	229	254	280	305	508	559	610	661	737	762	813	864	991	1067	1194

210-27 Valve Selection	100-01 Pattern: Globe (G), Angle (A), End Connections: Threaded (T), Grooved (GR), Flanged (F) Indicate Available Sizes															
	Inches	2	2½	3	4	6	8	10	12	14	16	18	20	24	30	36
	mm	50	65	80	100	150	200	250	300	350	400	450	500	600	750	900
Main Valve 100-01	Pattern	G, A	G, A	G, A	G, A	G, A	G, A	G, A	G, A	G, A	G, A	G	G	G, A	G	G
	End Detail	T, F, Gr	T, F, Gr*	T, F, Gr	F, Gr	F, Gr*	F, Gr*	F	F	F	F	F	F	F	F	F
Suggested Flow (gpm)	Maximum	210	300	460	800	1800	3100	4900	7000	8400	11000	14000	17000	25000	42000	50000
	Maximum Intermittent	260	370	580	990	2250	3900	6150	8720	10540	13700	17500	21700	31300	48000	62500
Suggested Flow (Liters/Sec)	Maximum	13	19	29	50	113	195	309	442	530	694	883	1073	1577	2650	3150
	Maximum Intermittent	16	23	37	62	142	246	387	549	664	863	1104	1369	1972	3028	3940

100-01 Series is the full internal port Hytrol.

*Globe Grooved Only

Pilot System Specifications



The Cla-Val Model CDS6A Altitude Pilot Control is a spring-loaded, three-way, diaphragm-actuated control that provides high-level shutoff for Cla-Val 210 Series Altitude Control Valves. The CDS6A controls the high water level in a reservoir or tank without the need for floats or other devices. It is a non-throttling pilot that remains fully open until the reservoir reaches the high level shutoff point. High accuracy is assured by remotely sensing the pressure head of the reservoir or tank. The single adjusting nut can be easily set in the field to close the main valve when liquid level reaches the desired high level set-point within five adjustment ranges.

CDS6A Adjustment Ranges

- 5 - 40 ft.
- 30 - 80 ft.
- 70 - 120 ft.
- 110 - 160 ft.
- 150 - 200 ft.

Temperature Range

Water: to 180°F

If flowing line pressure is less than 10 psi, consult factory for full details. If inlet pressure is above 150 psi, consult factory for recommendations.

Fluids

Air, water, light oils

Rubber Parts:

Buna-N® Synthetic Rubber

Solenoid Control

Body:

Brass ASTM B283

Enclosure:

NEMA Type 1,2,3,3S,4,4X general purpose watertight*

NEMA Type 6,6P,7,9 watertight Explosion Proof available.

Voltages:

- 110, 220 - 50Hz AC
- 24, 120, 240, 480 - 60Hz AC
- 6, 12, 24, 120, 240 - DC
- Others available.

Max. operating pressure differential:
200 psi*

Coil:

Insulation molded Class	F
Watts AC	6
AC Volt Amps Inrush	30
AC Volt Amps Holding	16
Watts DC	10.6

Manual operator available.

*Supplied unless otherwise specified



When Ordering, Please Specify

1. Catalog No. 210-27
2. Valve Size
3. Pattern - Globe or Angle
4. Pressure Class
5. Threaded or Flanged
6. Materials Desired
7. Energized or de-energized to open Main Valve
8. Solenoid Enclosure, Voltage & Hertz, Coil Insulation and Max. Operating Pressure Differential
9. Adjustment Range
10. Desired Options
11. When Vertically Installed



CLA-VAL

1701 Placentia Avenue • Costa Mesa, CA 92627

800-942-6326 • Fax: 949-548-5441 • Web Site: cla-val.com • E-mail: info@cla-val.com

CLA-VAL CANADA
4687 Christie Drive
Beamsville, Ontario
Canada L0R 1B4
Phone: 905-563-4963
E-mail sales@cla-val.ca

CLA-VAL EUROPE
Chemin des Mésanges 1
CH-1032 Romanel/
Lausanne, Switzerland
Phone: 41-21-643-15-55
E-mail: cla-val@cla-val.ch

CLA-VAL UK
Dainton House, Goods Station Road
Tunbridge Wells
Kent TN11 2 DH England
Phone: 44-1892-514-400
E-mail: info@cla-val.co.uk

CLA-VAL FRANCE
Porte du Grand Lyon 1
ZAC du Champ du Pérrier
France - 01700 Neyron
Phone: 33-4-72-25-92-93
E-mail: cla-val@cla-val.fr

CLA-VAL PACIFIC
45 Kennaway Road
Woolston, Christchurch, 8023
New Zealand
Phone: 64-39644860
www.cla-valpacific.com
E-mail: info@cla-valpacific.com