

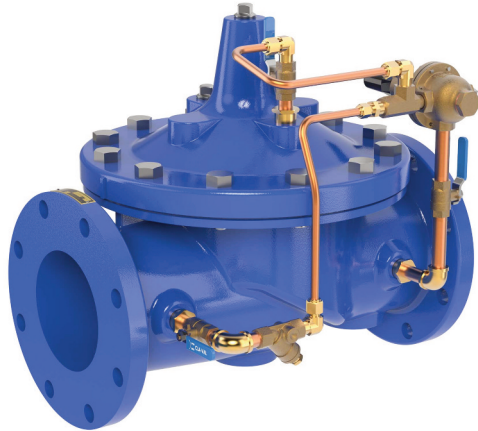

Pressure Reducing Valve



- Sensitive and Accurate Pressure Control
- Easy Adjustment and Maintenance
- Optional Check Feature
- Fully Supported Frictionless Diaphragm

The Cla-Val Model 90-37 Pressure Reducing Valve automatically reduces a higher inlet pressure to a steady lower downstream pressure, regardless of changing flow rate and/or varying inlet pressure. This valve is an accurate, pilot-operated regulator capable of holding downstream pressure to a pre-determined limit. When downstream pressure exceeds the pressure setting of the control pilot, the main valve and pilot valve close drip-tight.

If a check feature is added, and a pressure reversal occurs, the downstream pressure is admitted in the main valve cover chamber, closing the valve to prevent return flow.

Schematic Diagram

Item	Description
1	100-01 Hytrol Main Valve (full port)
2	X47A Ejector
3	CRD Pressure Reducing Control

Optional Features

Item	Description
A	X46A Flow Clean Strainer
B	CK2 Isolation Valve
C	CV Flow Control (Closing)*
D	Check Valves with Isolation Valve
S	CV Flow Control (Opening)
Y	X43 "Y" Strainer

*The closing speed control (optional) on this valve should always be open at least three (3) turns off its seat.

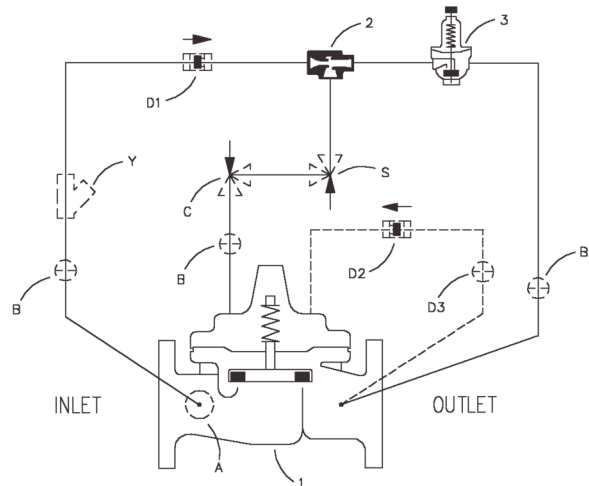

Typical Applications

Typical applications include pressure reducing valve station using Model 90-37BY and Model 90-37AS in parallel to handle wide range of flow rates. Larger Model 90-37BY valve meets requirements of peak loads and smaller Model 90-37AS handles low flows.

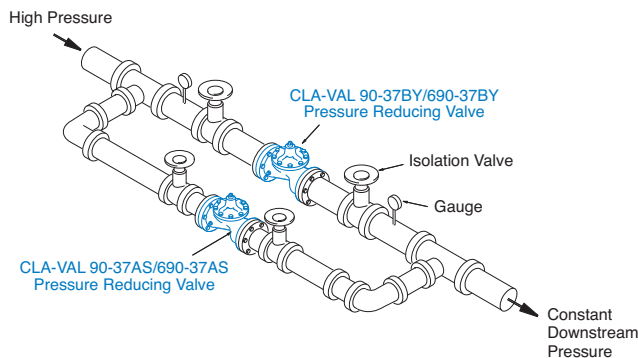

Cla-Val Model 90-37KO Pressure Reducing Valve with Anti-Cavitation Trim provides for optimum downstream pressure control while reducing noise and eliminating damage associated with cavitation.

See Cavitation Guide to determine if the valve is a candidate for the KO Anti-Cavitation Trim.

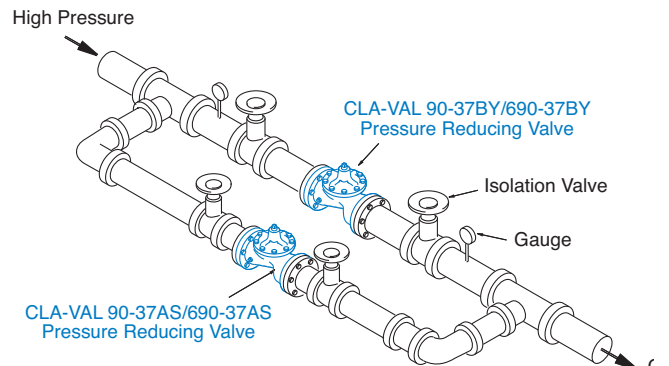

Model 90-37 (Uses 100-01 Hytrol Main Valve)

Pressure Ratings (Recommended Maximum Pressure - psi)

Valve Body & Cover		Pressure Class				
		Flanged			Grooved	Threaded
Grade	Material	ANSI Standards*	150 Class	300 Class	300 Class	End‡ Details
ASTM A536	Ductile Iron	B16.42	250	400	400	400
ASTM A216-WCB	Cast Steel	B16.5	285	400	400	400
UNS 87850	Bronze	B16.24	225	400	400	400

Note: * ANSI standards are for flange dimensions only.
 Flanged valves are available faced but not drilled.
 ‡ End Details machined to ANSI B2.1 specifications.

Valves for higher pressure are available; consult factory for details

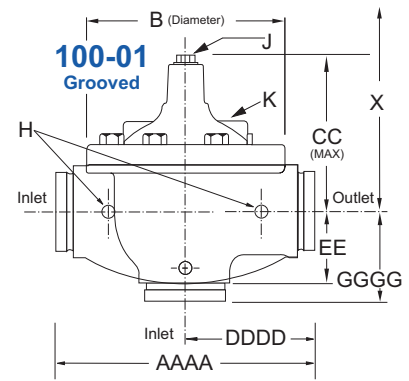
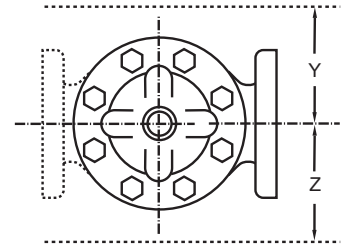
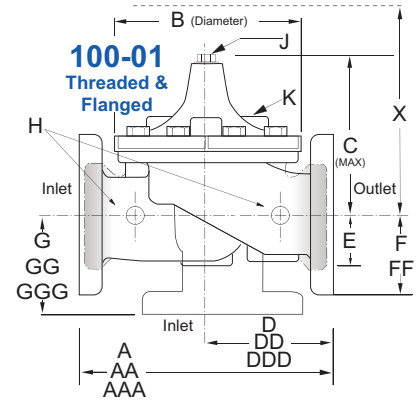

Materials

Component	Standard Material Combinations		
Body & Cover	Ductile Iron	Cast Steel	Bronze
Available Sizes (inches)	1" - 36"	1" - 16"	1" - 16"
Available Sizes (mm)	25 - 900 mm	25 - 400 mm	25 - 400 mm
Disc Retainer & Diaphragm Washer	Cast Iron	Cast Steel	Bronze
Trim: Disc Guide, Seat & Cover Bearing	Bronze is Standard Stainless Steel is Optional		
Disc	Buna-N® Rubber		
Diaphragm	Nylon Reinforced Buna-N® Rubber		
Stem, Nut & Spring	Stainless Steel		

For material options not listed, consult factory.
 Cla-Val manufactures valves in more than 50 different alloys.

Model 90-37 Dimensions (inches)

Valve Size (Inches)	1	1¼	1½	2	2½	3	4	6	8	10	12	14	16	18	20	24	30	36
A Threaded	7.25	7.25	7.25	9.38	11.00	12.50	—	—	—	—	—	—	—	—	—	—	—	—
AA 150 ANSI	—	—	8.50	9.38	11.00	12.00	15.00	20.00	25.38	29.75	34.00	39.00	41.38	46.00	52.00	61.50	63.00	72.75
AAA 300 ANSI	—	—	9.00	10.00	11.62	13.25	15.62	21.00	26.38	31.12	35.50	40.50	43.50	47.64	53.62	63.24	64.50	74.75
AAAA Grooved End	—	—	8.50	9.00	11.00	12.50	15.00	20.00	25.38	—	—	—	—	—	—	—	—	—
B Diameter	5.62	5.62	5.62	6.62	8.00	9.12	11.50	15.75	20.00	23.62	28.00	32.75	35.50	41.50	45.00	53.16	56.00	66.00
C Maximum	5.50	5.50	5.50	6.50	7.56	8.19	10.62	13.38	16.00	17.12	20.88	24.19	25.00	39.06	41.90	43.93	54.60	59.00
CC Maximum Grooved End	—	—	4.75	5.75	6.88	7.25	9.31	12.12	14.62	—	—	—	—	—	—	—	—	—
D Threaded	3.25	3.25	3.25	4.75	5.50	6.25	—	—	—	—	—	—	—	—	—	—	—	—
DD 150 ANSI	—	—	4.00	4.75	5.50	6.00	7.50	10.00	12.69	14.88	17.00	19.50	20.81	—	—	30.75	—	—
DDD 300 ANSI	—	—	4.25	5.00	5.88	6.38	7.88	10.50	13.25	15.56	17.75	20.25	21.62	—	—	31.62	—	—
DDDD Grooved End	—	—	—	4.75	—	6.00	7.50	—	—	—	—	—	—	—	—	—	—	—
E	1.12	1.12	1.12	1.50	1.69	2.06	3.19	4.31	5.31	9.25	10.75	12.62	15.50	12.95	15.00	17.75	21.31	24.56
EE Grooved End	—	—	2.00	2.50	2.88	3.12	4.25	6.00	7.56	—	—	—	—	—	—	—	—	—
F 150 ANSI	—	—	2.50	3.00	3.50	3.75	4.50	5.50	6.75	8.00	9.50	10.50	11.75	15.00	16.50	19.25	22.50	28.50
FF 300 ANSI	—	—	3.06	3.25	3.75	4.13	5.00	6.25	7.50	8.75	10.25	11.50	12.75	15.00	16.50	19.25	24.00	30.00
G Threaded	1.88	1.88	1.88	3.25	4.00	4.50	—	—	—	—	—	—	—	—	—	—	—	—
GG 150 ANSI	—	—	4.00	3.25	4.00	4.00	5.00	6.00	8.00	8.62	13.75	14.88	15.69	—	—	22.06	—	—
GGG 300 ANSI	—	—	4.25	3.50	4.31	4.38	5.31	6.50	8.50	9.31	14.50	15.62	16.50	—	—	22.90	—	—
GGGG Grooved End	—	—	—	3.25	—	4.25	5.00	—	—	—	—	—	—	—	—	—	—	—
H NPT Body Tapping	0.375	0.375	0.375	0.375	0.50	0.50	0.75	0.75	1.00	1.00	1.00	1.00	1.00	1.00	1.00	1.00	2.00	2.00
J NPT Cover Center Plug	0.25	0.25	0.25	0.50	0.50	0.50	0.75	0.75	1.00	1.00	1.25	1.50	2.00	1.00	1.00	1.00	2.00	2.00
K NPT Cover Tapping	0.375	0.375	0.375	0.375	0.50	0.50	0.75	0.75	1.00	1.00	1.00	1.00	1.00	1.00	1.00	1.00	2.00	2.00
Stem Travel	0.40	0.40	0.40	0.60	0.70	0.80	1.10	1.70	2.30	2.80	3.40	4.00	4.50	5.10	5.63	6.75	7.50	8.50
Approx. Ship Weight (lbs)	15	15	15	35	50	70	140	285	500	780	1165	1600	2265	2982	3900	6200	7703	11720
Approx. X Pilot System	11	11	11	13	14	15	17	29	31	33	36	40	40	43	47	68	79	85
Approx. Y Pilot System	9	9	9	9	10	11	12	20	22	24	26	29	30	32	34	39	40	45
Approx. Z Pilot System	9	9	9	9	10	11	12	20	22	24	26	29	30	32	34	39	42	47

Model 90-37 Metric Dimensions (Uses 100-01 Hytrol Main Valve)

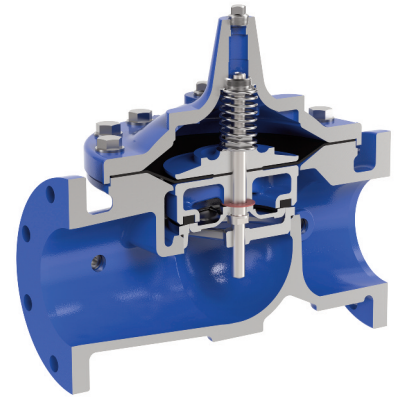
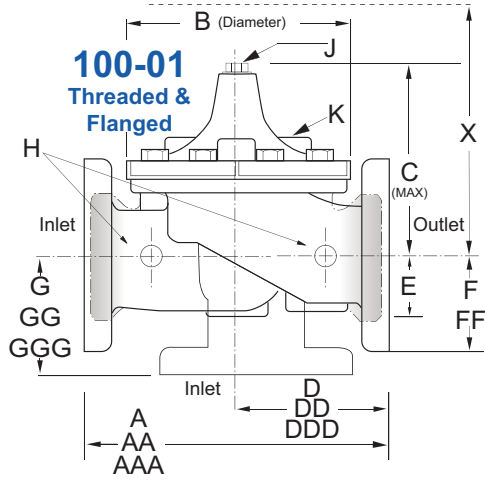

Model 100-01 Full Port Hytrol Main Valve

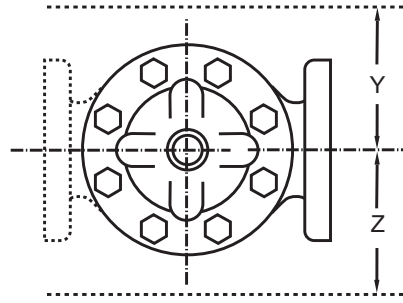
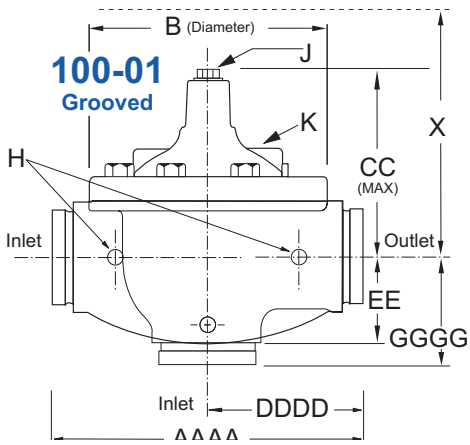

Model 90-37 Dimensions (mm)

Valve Size (mm)	25	32	40	50	65	80	100	150	200	250	300	350	400	450	500	600	750	900
A Threaded	184	184	184	238	279	318	—	—	—	—	—	—	—	—	—	—	—	—
AA 150 ANSI	—	—	216	238	279	305	381	508	645	756	864	991	1051	1168	1321	1562	1600	1848
AAA 300 ANSI	—	—	229	254	295	337	397	533	670	790	902	1029	1105	1210	1326	1606	1638	1899
AAAA Grooved End	—	—	216	228	279	318	381	508	645	—	—	—	—	—	—	—	—	—
B Diameter	143	143	143	168	203	232	292	400	508	600	711	832	902	1054	1143	1350	1422	1676
C Maximum	140	140	140	165	192	208	270	340	406	435	530	614	635	992	1064	1116	1387	1499
CC Maximum Grooved End	—	—	120	146	175	184	236	308	371	—	—	—	—	—	—	—	—	—
D Threaded	83	83	83	121	140	159	—	—	—	—	—	—	—	—	—	—	—	—
DD 150 ANSI	—	—	102	121	140	152	191	254	322	378	432	495	528	—	—	781	—	—
DDD 300 ANSI	—	—	108	127	149	162	200	267	337	395	451	514	549	—	—	803	—	—
DDDD Grooved End	—	—	—	121	—	152	191	—	—	—	—	—	—	—	—	—	—	—
E	29	29	29	38	43	52	81	110	135	235	273	321	394	329	381	451	541	624
EE Grooved End	—	—	52	64	73	79	108	152	192	—	—	—	—	—	—	—	—	—
F 150 ANSI	—	—	64	76	89	95	114	140	171	203	241	267	298	381	419	489	572	724
FF 300 ANSI	—	—	78	83	95	105	127	159	191	222	260	292	324	381	419	489	610	762
G Threaded	48	48	48	83	102	114	—	—	—	—	—	—	—	—	—	—	—	—
GG 150 ANSI	—	—	102	83	102	102	127	152	203	219	349	378	399	—	—	560	—	—
GGG 300 ANSI	—	—	102	89	110	111	135	165	216	236	368	397	419	—	—	582	—	—
GGGG Grooved End	—	—	—	83	—	108	127	—	—	—	—	—	—	—	—	—	—	—
H NPT Body Tapping	0.375	0.375	0.375	0.375	0.50	0.50	0.75	0.75	1.00	1.00	1.00	1.00	1.00	1.00	1.00	1.00	2.00	2.00
J NPT Cover Center Plug	0.25	0.25	0.25	0.50	0.50	0.50	0.75	0.75	1.00	1.00	1.25	1.50	2.00	1.00	1.00	1.00	2.00	2.00
K NPT Cover Tapping	0.375	0.375	0.375	0.375	0.50	0.50	0.75	0.75	1.00	1.00	1.00	1.00	1.00	1.00	1.00	1.00	2.00	2.00
Stem Travel	10	10	10	15	18	20	28	43	58	71	86	102	114	130	143	171	190	216
Approx. Ship Weight (kgs)	7	7	7	16	23	32	64	129	227	354	528	726	1027	1353	1769	2812	3494	5316
Approx. X Pilot System	280	280	280	331	356	381	432	737	788	839	915	1016	1016	1093	1194	1728	2007	2159
Approx. Y Pilot System	229	229	229	229	254	280	305	508	559	610	661	737	762	813	864	991	1016	1143
Approx. Z Pilot System	229	229	229	229	254	280	305	508	559	610	661	737	762	813	864	991	1067	1194

90-37 Valve Selection	100-01 Pattern: Globe (G), Angle (A), End Connections: Threaded (T), Grooved (GR), Flanged (F) Indicate Available Sizes																		
	Inches	1	1¼	1½	2	2½	3	4	6	8	10	12	14	16	18	20	24	30	36
	mm	25	32	40	50	65	80	100	150	200	250	300	350	400	450	500	600	750	900
Main Valve 100-01	Pattern	G, A	G, A	G, A	G, A	G, A	G, A	G, A	G, A	G, A	G, A	G, A	G, A	G	G	G, A	G	G	
	End Detail	T	T	T, F, Gr*	T, F, Gr	T, F, Gr*	T, F, Gr	F, Gr	F, Gr*	F, Gr*	F	F	F	F	F	F	F	F	F
Suggested Flow (gpm)	Maximum	55	93	125	210	300	460	800	1800	3100	4900	7000	8400	11000	14000	17000	25000	42000	50000
	Maximum Intermittent	68	120	160	260	370	580	990	2250	3900	6150	8720	10540	13700	17500	21700	31300	48000	62500
	Minimum	1	1	1	1	2	2	4	10	15	35	50	70	95	120	150	275	450	650
Suggested Flow (Liters/Sec)	Maximum	3.5	6	8	13	19	29	50	113	195	309	442	530	694	883	1073	1577	2650	3150
	Maximum Intermittent	4.3	7.6	10	16	23	37	62	142	246	387	549	664	863	1104	1369	1972	3028	3940
	Minimum	.03	.03	.03	.06	.09	0.13	0.25	0.63	0.95	2.2	3.2	4.4	6.0	7.6	9.5	17.4	28.4	41.0

100-01 Series is the full internal port Hytrol.

For Lower Flows Consult Factory

*Globe Grooved Only

Pilot System Specifications



Adjustment Ranges

2 to 30 psi
15 to 75 psi
20 to 105 psi
30 to 300 psi*
150 to 600 psi (CRD-18)

*Supplied unless otherwise specified

Temperature Range
Water: to 180°F/ 82°C

Materials

Standard Pilot System Materials

Pilot Control: Low Lead Bronze
Trim: Stainless Steel Type 303
Rubber: Buna-N® Synthetic Rubber

Optional Pilot System Materials

Pilot Systems are available with optional Aluminum, Stainless Steel or Monel materials.

Note: Available with remote sensing control.

Valve Options

X141
Pressure
Gauge



X101AR Valve
Position Indicator
with Air Release



X101
Valve Position
Indicator

X144 e-FlowMeter



X43H
Strainer



Stainless
Steel Pilot



When Ordering, Please Specify

1. Catalog No. 90-37
2. Valve Size
3. Pattern - Globe or Angle
4. Pressure Class
5. Threaded or Flanged
6. Trim Material
7. Adjustment Range
8. Desired Options
9. When Vertically Installed



E-90-37 (R-03/2019)

CLA-VAL

1701 Placentia Avenue • Costa Mesa, CA 92627

800-942-6326 • Fax: 949-548-5441 • Web Site: cla-val.com • E-mail: info@cla-val.com

CLA-VAL CANADA
4687 Christie Drive
Beamsville, Ontario
Canada L0R 1B4
Phone: 905-563-4963
E-mail: sales@cla-val.ca

CLA-VAL EUROPE
Chemin des Mésanges 1
CH-1032 Romanel/
Lausanne, Switzerland
Phone: 41-21-643-15-55
E-mail: cla-val@cla-val.ch

CLA-VAL UK
Dainton House, Goods Station Road
Tunbridge Wells
Kent TN11 2 DH England
Phone: 44-1892-514-400
E-mail: info@cla-val.co.uk

CLA-VAL FRANCE
Porte du Grand Lyon 1
ZAC du Champ du Périer
France - 01700 Neyron
Phone: 33-4-72-25-92-93
E-mail: cla-val@cla-val.fr

CLA-VAL PACIFIC
45 Kennaway Road
Woolston, Christchurch, 8023
New Zealand
Phone: 64-39644860
www.cla-valpacific.com
E-mail: info@cla-valpacific.com